

OM Series

Open-Frame Industrial Touch Monitor

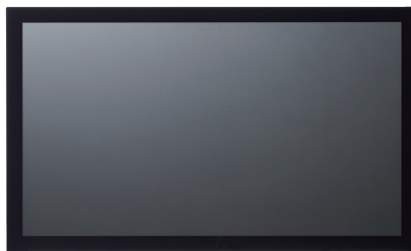

Features

- 10.1"/15.6"/18.5"/21.5"/23.8"/27"/32"/43" 16:9 LCD panel with LED backlight with up to 50,000 service life
- 10-point PCAP touchscreen
- Anti-fingerprint surface treatment for ease of cleaning and enhanced readability
- Wide viewing angles support for both portrait and landscape modes
- IP rating for water and dust protection
- Ease for deployment (support wall/panel/VESA mount)

Ordering Information

- OM-101
10.1" Open-frame industrial touch monitor
- OM-156
15.6" Open-frame industrial touch monitor
- OM-185
18.5" Open-frame industrial touch monitor
- OM-215
21.5" Open-frame industrial touch monitor
- OM-238
23.8" Open-frame industrial touch monitor
- OM-270
27.0" Open-frame industrial touch monitor
- OM-320
32.0" Open-frame industrial touch monitor
- OM-430
43.0" Open-frame industrial touch monitor

Optional Accessories

- Adapter
12V 60W power adapter
- Mounting kit (panel mount)

Specifications

Model Name	OM-101	OM-156	OM-185	OM-215	OM-238	OM-270
Display						
Size	10.1"	15.6"	18.5"	21.5"	23.8"	27"
Resolution	1280 x 800	1920 x 1080				
Aspect Ratio	16:9					
Color	16.7M					
Brightness (w/ touch)	400 nits				200 nits	240 nits
Backlight Life (Hrs)	50,000			30,000		40,000
Viewing Angle (U/D/R/L)	89/89/89/89				85/85/85/85	
Contrast Ratio	800:1	1000:1			3000:1	
Touchscreen	10-point, PCAP, Anti-fingerprint coating					
Bonding	Air bonding					
I/O						
USB Port	USB type B (for touch)					
Video	HDMI x1, VGA x1					
Audio	w/o Audio					
Environmental						
Operating Temperature	-20°C to 70°C	0°C to 70°C	0°C to 60°C	0°C to 50°C		
Storage Temperature	-20°C to 70°C			-20°C to 60°C		
Humidity	10% to 80% @ 40°C (non-condensing)					
Surface Hardness	7H					
Vibration	Operating: 1G random 5 to 500Hz					
Shock	Operating: 20G acceleration part to part, 11ms					
IP Rating	Front IP65					
Power Input	DC-12V 5A Max.					
Power Consumption	5.7 W	13.9 W	20 W	25.4 W	17.5 W	21.5 W
Mechanical						
Net Weight/ Gross Weight	1.6 kgs /2.1 kgs	2.9 kgs /3.6 kgs	4.2 kgs /5.2 kgs	4.8 kgs /6.0 kgs	6.2kg /7.2kg	7.5kg /8.0kg
Packing Dimensions (H x W x D)	330 x 320 x 180	490 x 380 x 190	430 x 610 x 160	640 x 480 x 160	695 x 488 x 175	775 x 538 x 180
Mounting	VESA Mount (MIS-D 75mm x 75mm, 100mm x 100mm) Panel, and Wall mount					

Specifications



Model Name	OM-320	OM-430
Display		
Size	32"	43"
Resolution	1920 x 1080	
Aspect Ratio	16:9	
Color	16.7M	
Brightness (w/ touch)	400 nits	
Backlight Life (Hrs)	50,000	
Viewing Angle (U/D/R/L)	89/89/89/89	
Contrast Ratio	4000:1	
Touchscreen	10-point, PCAP, Anti-fingerprint coating	
Bonding	Air bonding	
I/O		
USB Port	USB type B (for touch)	
Video	HDMI x1, VGA x1, DVI x1, DP 1.2 x1	
Audio	w/o Audio	
Environmental		
Operating Temperature	0°C to 40°C	
Storage Temperature	-20°C to 60°C	
Humidity	10% to 90% (non-condensing)	
Surface Hardness	≥6H	
Vibration	Operating: 1.5G random 10 to 200Hz	
Shock	NA	
IP Rating	Front IP65	
Power Input	DC-24V 5A Max.	
Power Consumption	38.4 W	50.4 W
Mechanical		
Net Weight/ Gross Weight	14.2kg	23.5kg
Packing Dimensions (H x W x D)	630 x 920 x 160	800 x 1200 x 220
Mounting	VESA Mount 200 x 200 mm (M6), M4 Rear mount x 12	200 x 200 mm (M6) M4 Rear mount x 8

Dimensions

OM-101

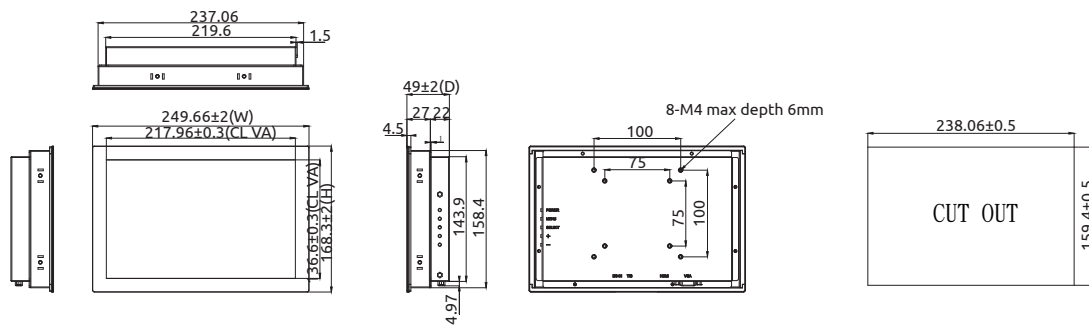

OM-156

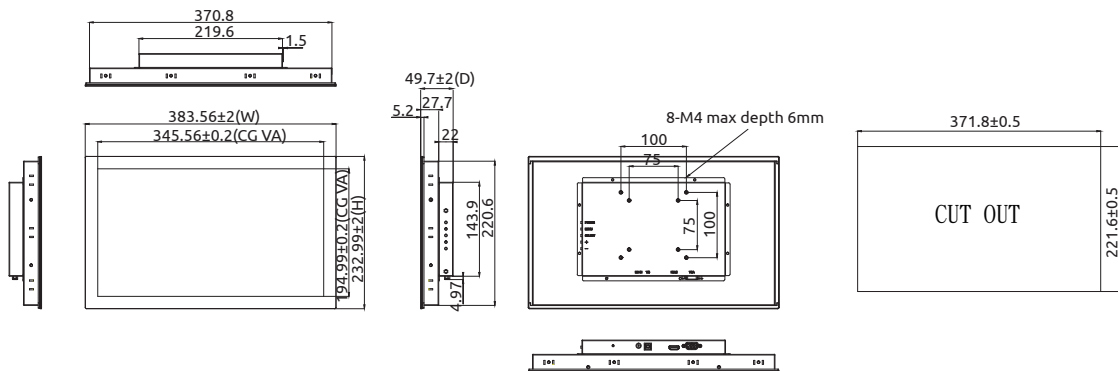

OM-185

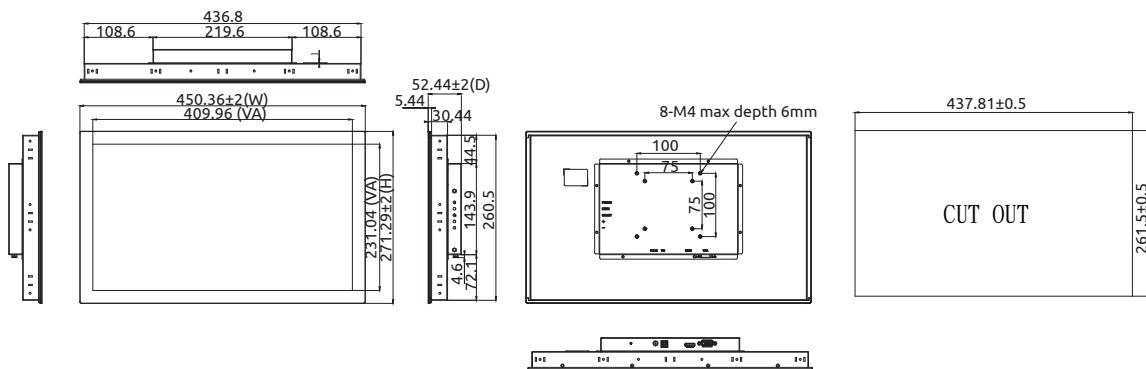

Dimensions

OM-215

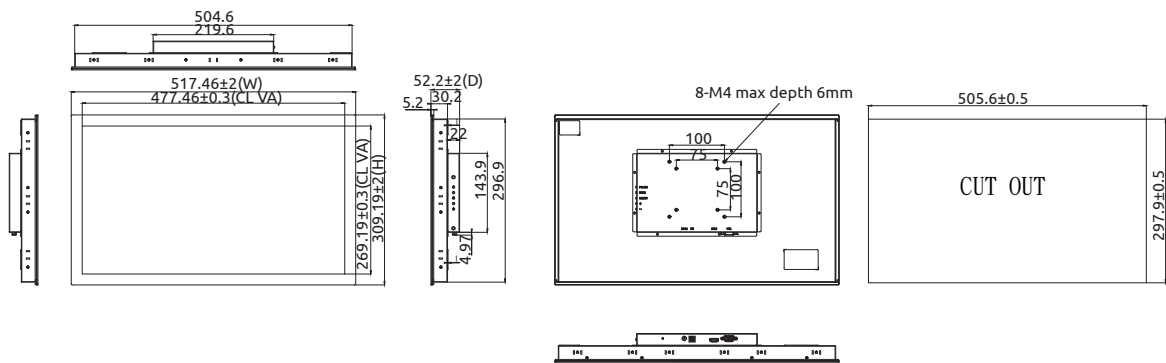

OM-238

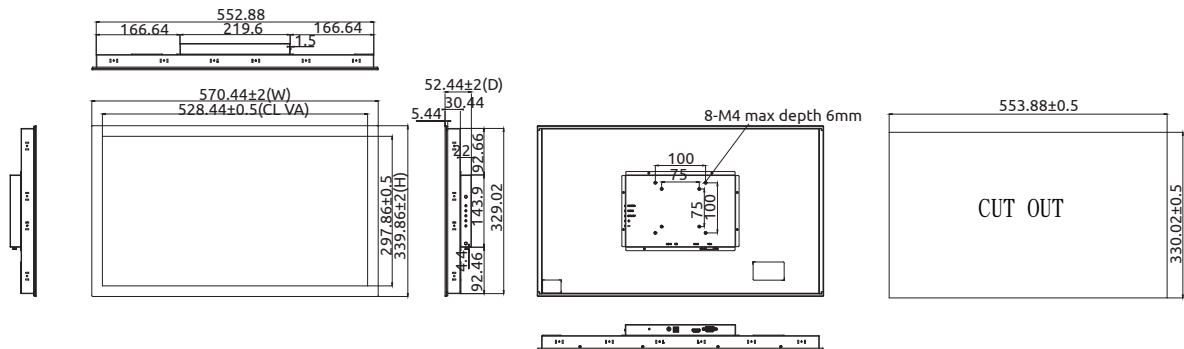

OM-270

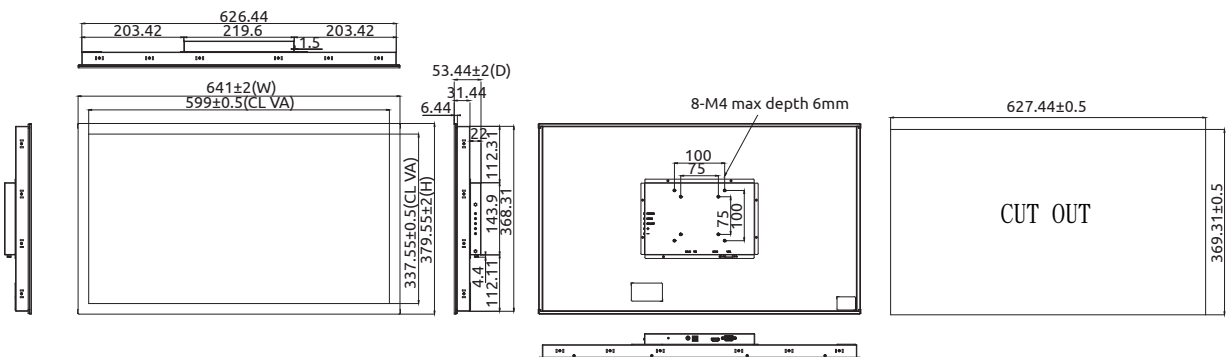

Dimensions

OM-320

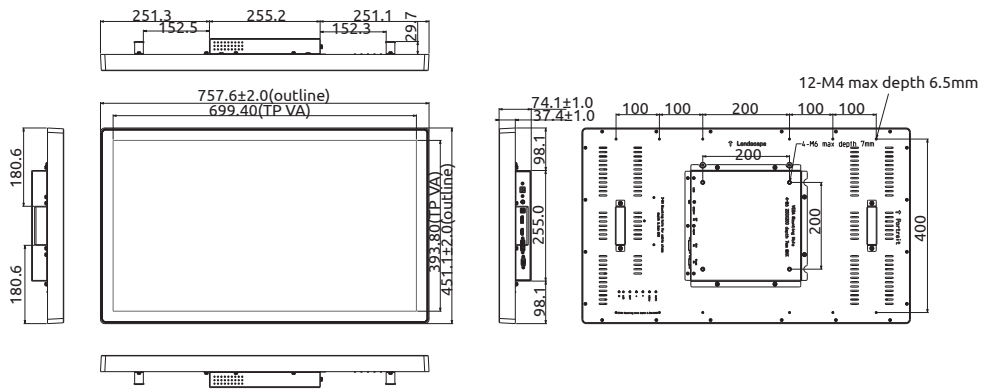

OM-430

